

# TS-32 INSTRUCTION SHEET

LBI32636

Reprinted by permission of



**Communications Specialists**

426 W. Taft Ave., Orange, CA 92667

(714) 998-3021 (California) / (800) 854-0547

**NOTES:**

- 1 - Remove when using OUT-1
- 2 - Remove when using OUT-2
- 3 - By-pass Regulator when supply voltage is less than 9.0 VDC.
- 4 - BIAS Voltages:
 

A = 7.9V
±10% @ Vin = 12.5V
B = 4.3V
C = 3.5V
D = 3.5V

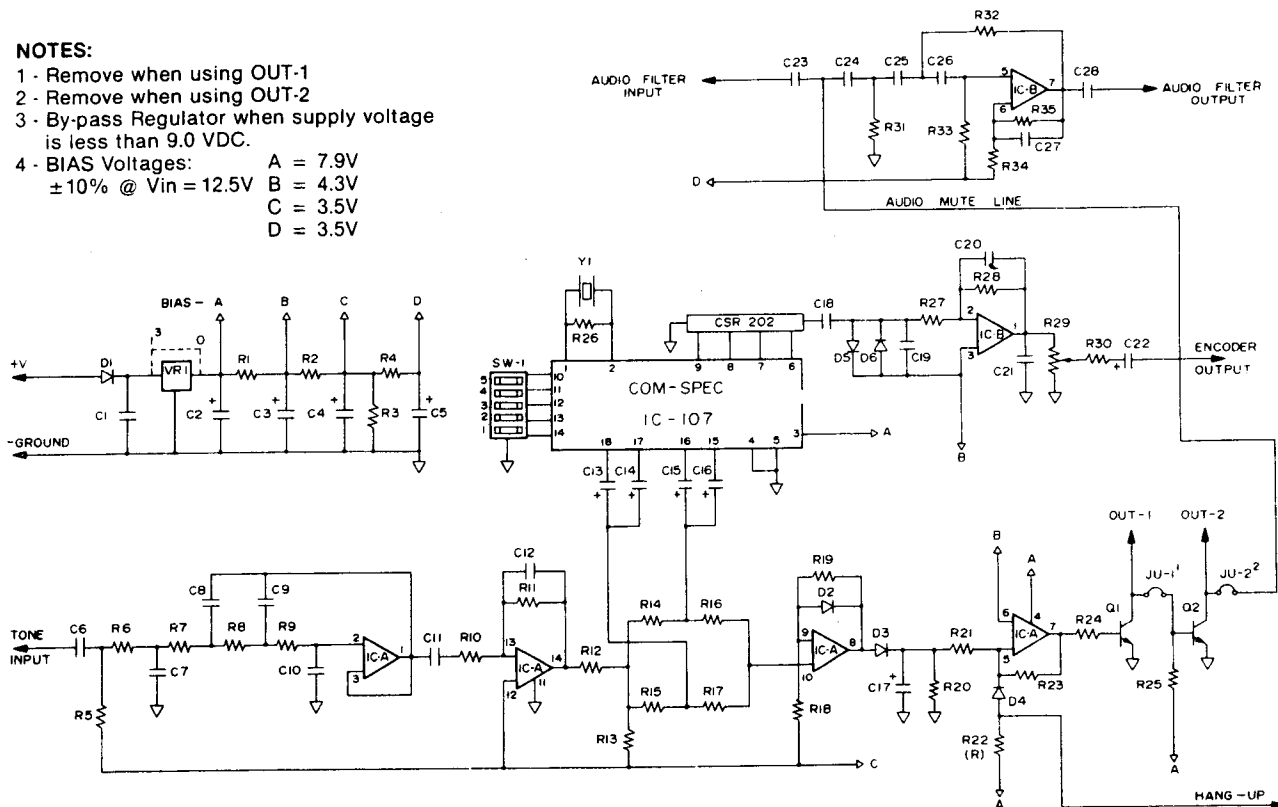

**DIP SWITCH PROGRAMMING  
(FOR CTCSS PRODUCTS)**

#	FREQ.	CODE	SWITCH NUMBER*				
			5	4	3	2	1
1	67.0	XZ	0	0	0	0	0
2	71.9	XA	0	0	0	0	1
3	74.4	WA	0	0	0	1	0
4	77.0	XB	0	0	0	1	1
5	79.7	SP	0	0	1	0	0
6	82.5	YZ	0	0	1	0	1
7	85.4	YA	0	0	1	1	0
8	88.5	YB	0	0	1	1	1
9	91.5	ZZ	0	1	0	0	0
10	94.8	ZA	0	1	0	0	1
11	97.4	ZB	0	1	0	1	0
12	100.0	1Z	0	1	0	1	1
13	103.5	1A	0	1	1	0	0
14	107.2	1B	0	1	1	0	1
15	110.9	2Z	0	1	1	1	0
16	114.8	2A	0	1	1	1	1
17	118.8	2B	1	0	0	0	0
18	123.0	3Z	1	0	0	0	1
19	127.3	3A	1	0	0	1	0
20	131.8	3B	1	0	0	1	1
21	136.5	4Z	1	0	1	0	0
22	141.3	4A	1	0	1	0	1
23	146.2	4B	1	0	1	1	0
24	151.4	5Z	1	0	1	1	1
25	156.7	5A	1	1	0	0	0
26	162.2	5B	1	1	0	0	1
27	167.9	6Z	1	1	0	1	0
28	173.8	6A	1	1	0	1	1
29	179.9	6B	1	1	1	0	0
30	186.2	7Z	1	1	1	0	1
31	192.8	7A	1	1	1	1	0
32	203.5	M1	1	1	1	1	1

\*CLOSED = 0 (ON)  
OPEN = 1 (OFF)

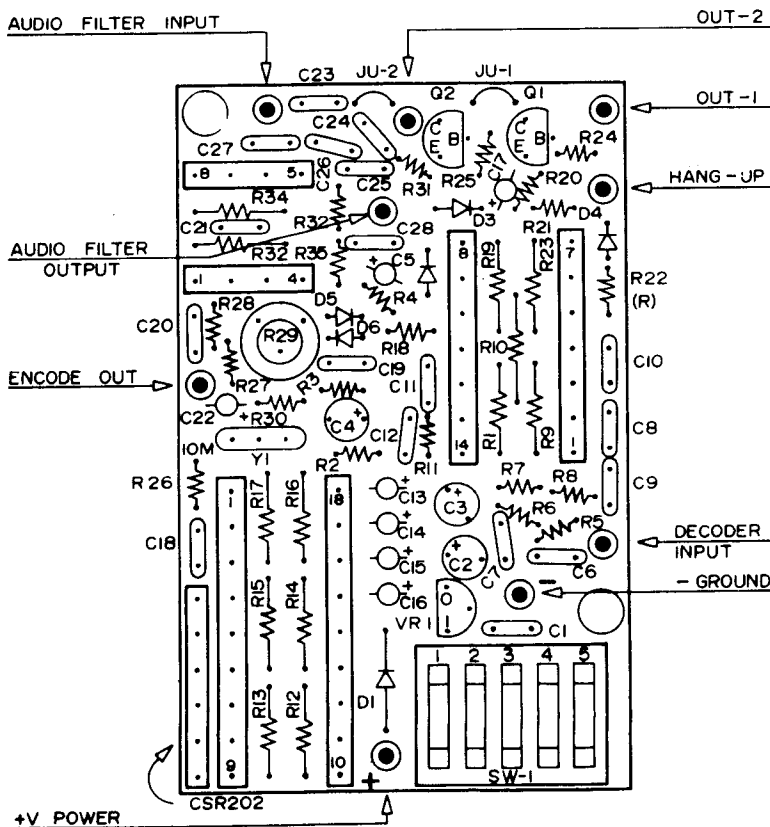

## TS-32 ENCODER/DECODER PARTS LIST

R1 - 10K	1/8 watt	5%	carbon	film	resistor	\$.31 ea.	C8 - 3300pf	50v	CW15	ceramic	1.25 ea.
R2 - 2.2K	"	"	"	"	"	.31 ea.	C9 - 3300pf	"	"	"	1.25 ea.
R3 - 10K	"	"	"	"	"	.31 ea.	C10 - 220pf	"	"	"	1.00 ea.
R4 - 100K	"	"	"	"	"	.31 ea.	C11 - .22uf	"	"	"	2.25 ea.
R5 - 1Meg	"	"	"	"	"	.31 ea.	C12 - 270pf	"	"	"	1.00 ea.
R6 - 1Meg	"	"	"	"	"	.31 ea.	C13 - 1uf	35v	tantalum	"	1.05 ea.
R7 - 470K	"	"	"	"	"	.31 ea.	C14 - 1uf	"	"	"	1.05 ea.
R8 - 560K	"	"	"	"	"	.31 ea.	C15 - 1uf	"	"	"	1.05 ea.
R9 - 470K	"	"	"	"	"	.31 ea.	C16 - 1uf	"	"	"	1.05 ea.
R10 - 5.6K	"	"	"	"	"	.31 ea.	C17 - 1uf	"	"	"	1.05 ea.
R11 - 2.7Meg	"	"	"	comp.	"	.31 ea.	C18 - .22uf	50v	CW15	ceramic	2.25 ea.
R12 - 150K	"	"	"	film	"	.31 ea.	C19 - 100pf	"	"	"	1.00 ea.
R13 - 15K	"	"	"	"	"	.31 ea.	C20 - .01uf	"	"	"	1.50 ea.
R14 - 100K	"	"	"	"	"	.31 ea.	C21 - 100 pf	"	"	"	1.00 ea.
R15 - 100K	"	"	"	"	"	.31 ea.	C22 - 1uf	35v	tantalum	"	1.05 ea.
R16 - 470K	"	"	"	"	"	.31 ea.	C23 - 1500pf	50v	CW15	ceramic	1.25 ea.
R17 - 470K	"	"	"	"	"	.31 ea.	C24 - .01uf	"	"	"	1.50 ea.
R18 - 5.6K	"	"	"	"	"	.31 ea.	C25 - 1500pf	"	"	"	1.25 ea.
R19 - 220K	"	"	"	"	"	.31 ea.	C26 - 1500pf	"	"	"	1.25 ea.
R20 - 470K	"	"	"	"	"	.31 ea.	C27 - 10pf	"	"	"	1.00 ea.
R21 - 120K	"	"	"	"	"	.31 ea.	C28 - .22uf	"	"	"	2.25 ea.
R22 - 47K	"	"	"	"	"	.31 ea.	D1 - 1N4148	silicon	diode	"	.15 ea.
R23 - 1Meg	"	"	"	"	"	.31 ea.	D2 - 1N4148	"	"	"	.15 ea.
R24 - 10K	"	"	"	"	"	.31 ea.	D3 - 1N4148	"	"	"	.15 ea.
R25 - 10K	"	"	"	"	"	.31 ea.	D4 - 1N4148	"	"	"	.15 ea.
R26 - 10Meg	"	10%	"	comp.	"	.31 ea.	D5 - 1N4148	"	"	"	.15 ea.
R27 - 15K	"	5%	"	film	"	.31 ea.	D6 - 1N4148	"	"	"	.15 ea.
R28 - 100K	"	"	"	"	"	.31 ea.	Z1 - CSR202	resistor	network	"	2.30 ea.
R29 - 5K	Meppco	potentiometer	"	"	"	1.39 ea.	Y1 - 1.000 Mhz	crystal	"	"	7.50 ea.
R30 - 1.2K	1/8 watt	5%	carbon	film	resistor	.31 ea.	SW-1 - 5 code	switch	"	"	2.45 ea.
R31 - 100K	"	"	"	"	"	.31 ea.	VR-1 - 78L08	regulator	"	"	1.00 ea.
R32 - 100K	"	"	"	"	"	.31 ea.	Q1 - MPS3390	transistor	"	"	.49 ea.
R33 - 1Meg	"	"	"	"	"	.31 ea.	Q2 - MPSA42	"	"	"	.85 ea.
R34 - 1Meg	"	"	"	"	"	.31 ea.	IC-B - TL062	"	"	"	2.20 ea.
R35 - 180K	"	"	"	"	"	.31 ea.	IC-A - LM324	microcircuit	"	"	3.00 ea.
C1 - .22uf	50v	CW15	ceramic	"	"	2.25 ea.	1 - IC-107	Com-Spec microcircuit	"	"	17.50 ea.
C2 - 10uf	16v	tantalum	"	"	"	1.40 ea.	2 - 4 pin strip	sockets	"	"	.35 ea.
C3 - 10uf	"	"	"	"	"	1.40 ea.	2 - 7 pin strip	sockets	"	"	.37 ea.
C4 - 10uf	"	"	"	"	"	1.40 ea.	2 - 9 pin strip	sockets	"	"	.39 ea.
C5 - 1uf	35v	"	"	"	"	1.05 ea.	8 - AMP	chassis pins	"	"	.10 ea.
C6 - .01uf	50v	CW15	ceramic	"	"	1.50 ea.	1 - Printed	circuit board	"	"	6.00 ea.
C7 - 3300pf	"	"	"	"	"	1.25 ea.	33 pos. Binary	Switch (for remote operation)	"	"	9.95 ea.

### MOUNTING

Mount the unit with the mounting items supplied. Do not mount the unit with silicon seal or any other type glues as this will void warranty.

If mounting with a 90° angle bracket, be sure to use the fiber washers supplied to avoid any circuit board shorts. Use the push-on wire kit supplied with the unit. **DO NOT** solder the wires to the board.

### PROGRAMMING

This programmable line of products uses a five position DIP switch to select the frequency desired. When the switches are in any particular position, this binary code tells the integrated circuit on which one of the coded tones the system will operate. For instance, if 1Z (100.0Hz.) is desired, the code required is located on the instruction sheet and the switches are programmed accord-

ingly. For example, the code for a 1Z is "11010", thus switch #1 is turned OFF (corresponding to a "1"), switch #2 is turned OFF, switch #3 is turned ON (corresponding to a "0"), switch #4 is OFF, and switch #5 is turned ON. By selecting the variable combinations of switch positions, all 32 tones can be accessed. Special tones are available also by using a different frequency crystal.

### POWER AND GROUND CONNECTIONS

The ground connection is typically very straight forward. The main ground foil on the printed circuit foil works well, or a connection to the chassis. Be careful of a radio which has multiple grounds, such as a chassis ground and a true vehicle ground. A GE Mastr Pro is a good example.

The power connection can be any unregulated positive D.C. voltage from +6.0 to +30.0V. Use a regulated voltage if it is conveniently available. However, with voltages below 9.0VDC, place a wire jumper across the regulator (VR-1) on the circuit board. See the circuit board pictorial for the placement of the jumper. This allows the board to work better at low voltages since the regulator only operates above 9.0V. Higher voltage can also be used, however an external limiting resistor will be required so the input does not exceed 30VDC. To determine the approximate value of the

resistor (in Kohms) use the following formula:  $R = (V - 22) / 8$ . A two watt resistor should be sufficient for voltages up to 200VDC. Refer to figures 1, 2, 3 for additional information. If polarity is reversed to the unit, it will not operate but will not be damaged. Use the following as a guide for obtaining proper operating voltage in different environments:

Mobiles, 12V negative ground—standard hook-up (see above).  
 Mobiles, 12V positive ground—reverse board +V and GND connections, return mike hang-up to +V instead of ground on decode models.

Mobiles, 6V pos. or neg. ground—use B+ dropping method.  
 Bases—use appropriate figure 1, 2, 3.

Portables, 9V or less—by-pass regulator, VR-1.

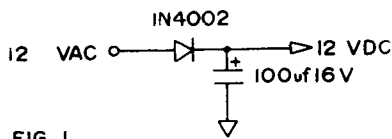

FIG. 1

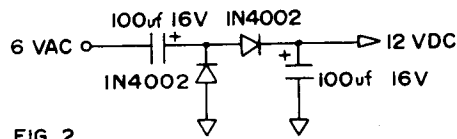

FIG. 2

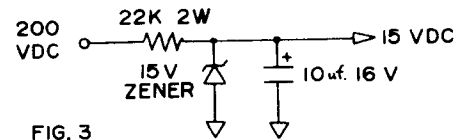

FIG. 3

## PROCEDURE FOR CONNECTING SUB-AUDIBLE ENCODER TONE TO TRANSMITTER

The encoder tone output is typically connected just prior to the modulator stage. Typical connections would be to the center of the deviation control, to the input of the final audio driver, to the varactor modulator diodes or to the manufacturer's normal connection point. This connection point varies with each different model radio, and you must determine which provides the best results. In a tube type transmitter, the grid of the modulator is often used, or a varactor kit should be used to modulate the crystal directly in a tube type or solid state transmitter, see figure E1. The VARACTOR (transistor base to collector junction of an NPN silicon transistor) changes A.C. voltage into changing capacitance which truly FM modulates the transmitter. No intermoding or distortion of the voice will be noted with this method. Various values of coupling capacitors are shown for different frequency ranges of the transmitter. A higher value of capacitance will increase the deviation level, however if the capacitance is too high, it may be difficult to set the transmitter on frequency. Varactor Kits are available from us for \$3.00 each. Use this method if other connection points prove unsuccessful.

**DO NOT** connect the encoder tone to the microphone input as this invariably causes excessive tone and harmonic distortion due to the frequency response of the transmitter's speech amplifier. The speech amplifier has a typical response of 300Hz to 3000Hz and does not permit the fundamental tone to be transmitted. This is the usual cause of a distorted tone output as monitored on a deviation scope.

The output of our encoder is low Z, so it is capable of driving low Z loads. Insufficient level output should never be a problem. However, if you are driving a high Z load such as 100k deviation pot, then a series isolation resistor should be used so the encoder will not load down the normal voice modulation. This resistor value must be determined experimentally, but a 100k resistor would be a good starting point. This value could change from 10K to 1 meg depending on the radio used.

If tone distortion continues to be a problem, then a capacitor can be placed on the tone output to provide additional filtering where required, see figure E2. This is most noticeable in phase modulators since the frequency response seems to be quite poor at the low end of the audio range. If you are using a deviation scope, then little spikes will be riding on the sine wave output, and this will sound like a buzz. The additional filtering will cure the problem. True FM modulators do not have this problem and are very easy to work with and interface very well with sub-audible encoders. These modulators can be identified quite easily since the audio is fed into a varactor which is often connected in parallel with the crystal. If the purity of the encoder output is in question, look at the output of the encoder with an oscilloscope.

Most UHF transmitters interface quite well with sub-audible encoders. This is primarily due to the high multiplication factor from the modulator to the final amplifier stage. Because of the lower number of multiplication stages in low band transmitters, sufficient deviation level can sometimes be difficult to obtain.

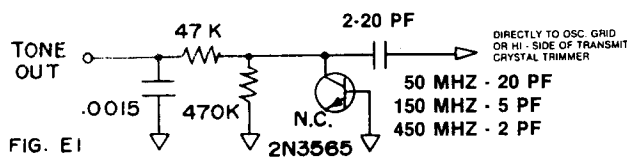

FIG. E1

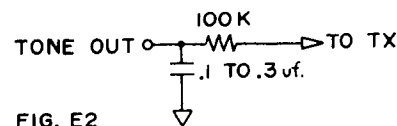

FIG. E2

## DECODER TONE INPUT

Hook tone input on board directly to the discriminator of the receiver forward of any metering resistance going to the discriminator jack. Some receivers provide amplified audio which is used to drive factory installed tone decoders. If your receiver has such an amplifier in it, it may be used. In tube type receivers, shielded wire may be necessary.

If decoder input level appears to be a problem, check for

square waves on pin 14 of the LM324 using an oscilloscope with tone input applied. If square waves are not present with tone input, then a higher level input will be required. Try the next audio amplification stage after the discriminator. **Do not use** the speaker output or the final audio amplifier for the tone input, as the frequency response is attenuated below 300Hz and provides insufficient tone for decoding.

## HANG-UP

In normal operation (tone squelch), the hang-up lead is grounded by the mike hookswitch until the mike is removed from the hanger. In order to get a decoded output, the **hang-up must be grounded**. Ungrounding the hang-up pin allows the switching circuit to un-mute the receiver to simulate a decode condition for monitoring of the channel prior to transmitting. If a hookswitch is not provided,

then a S.P.S.T. switch should be used to enable and disable the decoder. Resistor R22 (47K) is cut out if +V is supplied to the hang-up as in the RCA type of radios. Some mikes have the hang-up wire in the mike cord going to the rear mounting of the mike so no extra hang-up hookswitch is required.

## RECEIVER MUTING (Squelch Gating)

The TS-32 has two options for muting the circuitry in the receive audio chain. The easiest way is to use the muting option in the high pass audio filter. This is enabled by using JU-2 on the TS-32 PCB as shipped from the factory. When a signal of the proper frequency is decoded, the decoded output from OUT-2 turns on the audio being passed through the audio filter by controlling the mute line. When the tone input stops, OUT-2 returns to ground and mutes the audio. By using this method, no connections are necessary to the squelch circuitry.

The other method of receiver muting is to use one of the two decoder control outputs labeled OUT-1 and OUT-2. OUT-1, open collector transistor pulls OUT-1 to ground upon receipt of proper tone. OUT-2, open collector transistor pulls OUT-2 away from ground upon receipt of proper tone.

OUT-1 is used mainly for driving relays. A relay that draws less than 120ma. (100ohm coil) should be used. Be sure to put a diode across the relay to prevent damage to the 2N3390 transistor. The other side of the relay should be connected to the supply voltage of less than 30vdc. This output is used to mute the audio in some receivers also, but in most cases, OUT-2 will always be

used. Also, **be sure** to remove JU-1 when using OUT-1.

OUT-2 is the control output to use if the automatic muting feature in the audio filter is not desired. If using OUT-2, **be sure** to remove JU-2.

The OUT-2 transistor is a high voltage device and is therefore capable of muting even tube type receivers when required. The normal connection point in this type of receiver is to the plate of the squelch tube through a 1 meg. resistor as in a GE Progress Line. For solid state receivers, the normal connection point is to the collector of the squelch switch transistor. Where this point is not easily identified, the following procedure can be used to identify the proper point for the OUT-2 Connection:

1. Using a clip lead, connect one side to ground.
2. Connect 100 ohm resistor to the other end.
3. Using the open end of the resistor, probe around in the receiver **with the squelch open** to locate a point which will mute the receiver audio when the resistor is connected to that point. This point may be in the squelch circuitry, or possibly in the audio stages. When an IC is used for the audio section, often one pin on the IC will mute the audio.

## AUDIO HIGH PASS FILTER CONNECTIONS

The audio filter is used to remove the sub-audible tone from the received audio. The filter is not always required since the frequency response of most receivers is limited to 300HZ to 3000Hz. If the level of the tone is not objectional at normal listening levels then chances are that the filter will not be required.

In those cases where the filter is required, it will attenuate the encoded tone quite well with the attenuation down more than 35db at 100Hz.

The filter should be connected to a point in the receiver where the audio level is less than 1.5v RMS, and the power level is low. The speaker path would **not be** the place to connect the filter. Typical connection points would be in series off the center of the volume control, or directly off the discriminator output. Thus, the audio path off these points should be cut, then hook up the input

and output wires in series with that broken path. Make sure the audio passing through this point is A.C. coupled to the next stage, or the bias could be changed when the filter is connected in the circuit.

Automatic muting for the receiver is provided in the audio filter if desired. This is accomplished by JU-2 which connects the decoder output to the audio mute line coming from the audio filter. If this feature is not required then be sure to remove JU-2. See Squelch Gating for additional information.

If signal feed through is noticed when the filter is muted, then one of the alternate methods of audio muting should be used, or the filter should be connected in a different location in the receiver. This should not be necessary since the filter can mute the audio with up to 60db of attenuation.

## RF INTERFERENCE

Although our encoders are not susceptible to RF, care must be taken when locating the unit, and how the wires are routed. In most cases of RF interference it has been found that the RF is coupled into the leads of the encoder and then fed back into the radio itself where the RF upsets the bias conditions in the transmitter. This causes distortion and other unusual effects. But

under these conditions it will be noted that the encoder is still working properly. This is most common in portable hand held radios, since often the circuitry is compromised slightly to achieve the small size required. Often a small by-pass capacitor such as a 100pf. on the radio's circuit board works quite well. Also, keeping all leads as short as possible or re-routing the wires helps.

## MULTI-TONE APPLICATIONS

By adding a little additional circuitry, our programmable line of products may be frequency programmed by remote means. Since these products all use DC signals for switching, any number of tones may be switched in or out without being concerned with additional lead length, or stray capacitance affecting the frequency. This is a typical problem associated with tunable type units and also those using reeds.

There are a number of ways of changing frequencies from a remote location. The easiest way is to use a 33 position binary switch (available from us) which connects in parallel with the 5 position DIP switch on the circuit board. Thus all 32 tones may be accessed by rotating through all positions on the switch, with the first position on the switch being the off condition (see figure M1). When connections are made in this manner, position ONE will be the off condition, and the path from "G" to "H" will be open thereby removing power from the programmable board. Position TWO would be 67.0Hz (Group A), position three would be 71.9Hz, and so on up to position 33 which would be 203.5Hz. When using the binary switch be sure all five positions on the DIP switch are in the OFF condition.

The other method for adding additional frequencies is to use

a single pole rotary switch with as many positions as the number of different frequencies required. Using this method, a diode for line isolation must be used in each leg of the program code which requires a "0" or a ground for programming (see figure M2). In this example, three frequencies are required to operate a three site repeater system. The sub-audible tones required to access all three sites are 5Z (151.4Hz), 4B (146.2Hz), and YZ (82.5Hz). The frequency code is located on the programming chart for each of the three frequencies and these codes are converted to the appropriate diode array for each frequency. For example, position number two on the rotary switch must be 146.2Hz. This corresponds to "10110" on the program chart. By looking at this code, it is determined that 2 diodes will be required on the locations containing a "0", and no connection is required in the locations containing a "1". Thus the lines from pin 11, and pin 14, on IC-107 are pulled to ground through the series diodes when the rotary switch is in position number two. This method works quite well where space is a factor, and is best when only a few frequencies are required. Be sure all five positions on the DIP switch are in the OFF condition when changing frequencies remotely.

FIGURE - M1

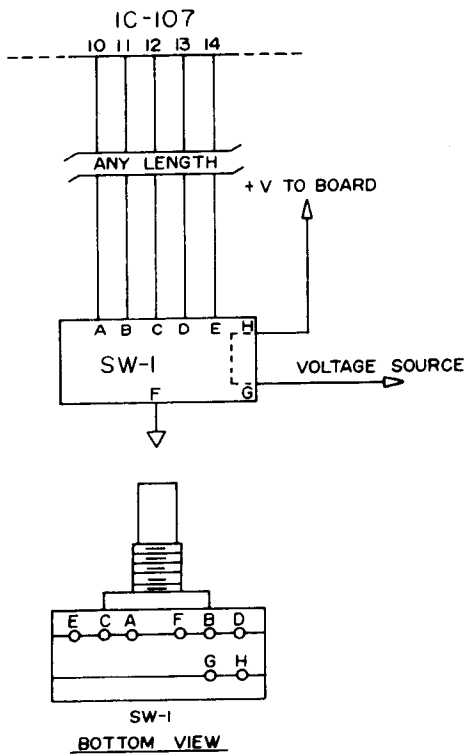
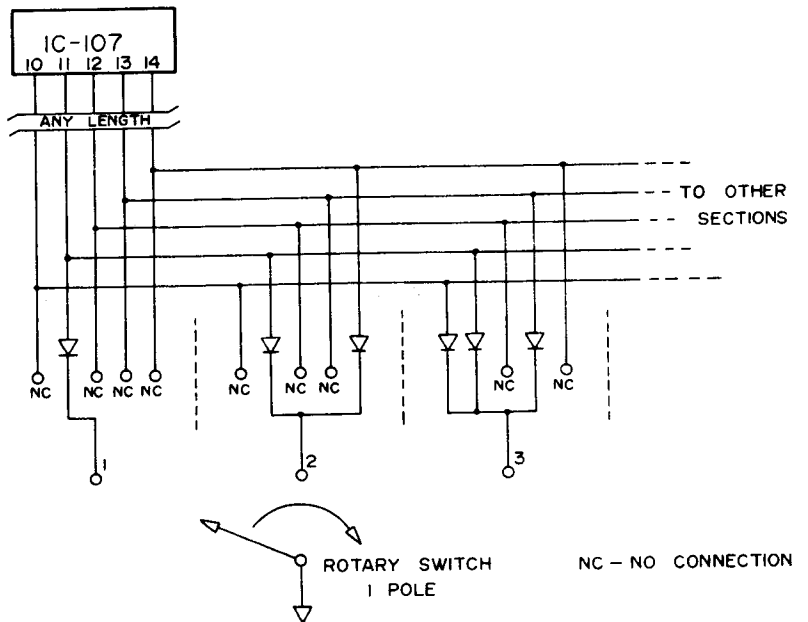
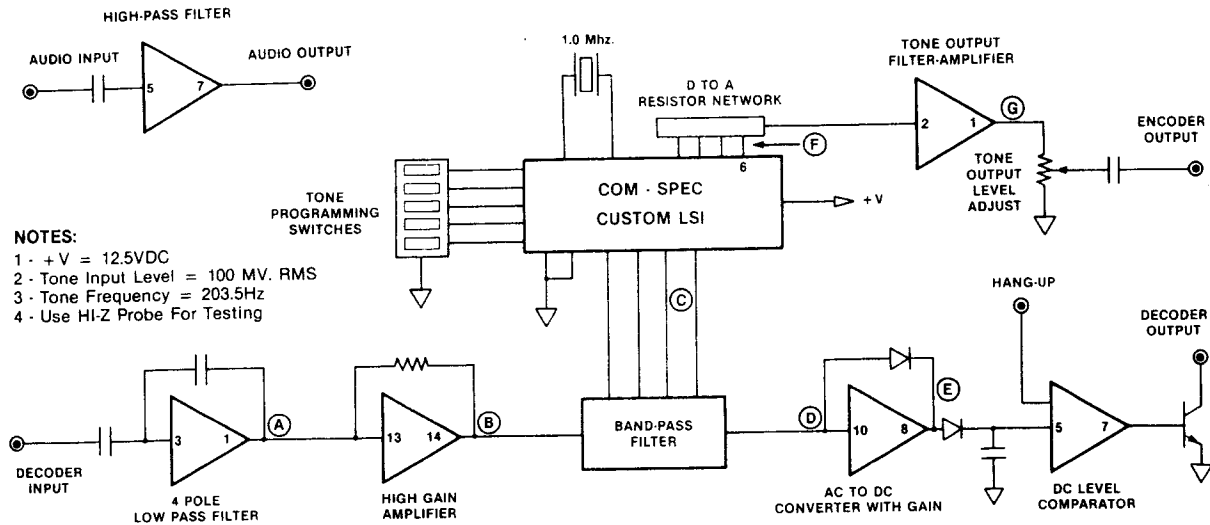

FIGURE - M2



# TROUBLE-SHOOTING THE TS-32



- NOTES:**  
 1 - +V = 12.5VDC  
 2 - Tone Input Level = 100 MV. RMS  
 3 - Tone Frequency = 203.5Hz  
 4 - Use HI-Z Probe For Testing

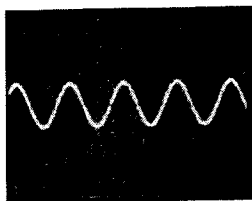

(A) 100mv/cm 2ms/cm

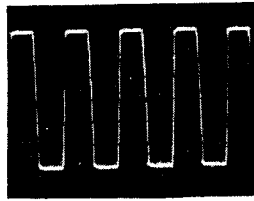

(B) 1v/cm 2ms/cm

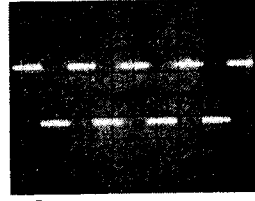

(C) 100mv/cm 2ms/cm

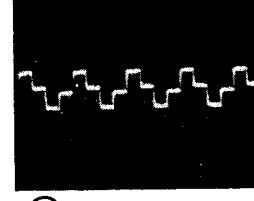

(D) 100mv/cm 2ms/cm

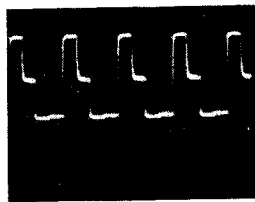

(E) 1v/cm 2ms/cm

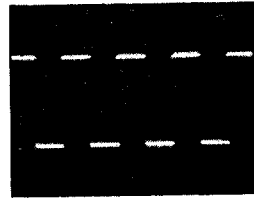

(F) 2v/cm 2ms/cm

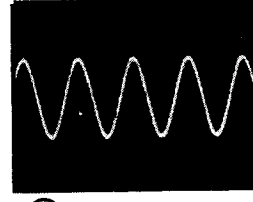

(G) 1v/cm 2ms/cm

## THEORY OF OPERATION

### ENCODE SECTION

The desired encoder output signal is derived from a highly stable 1,000MHz. quartz crystal oscillator. This oscillator is contained inside the IC-107, which is a custom LSI consisting of in excess of 1000 CMOS gates. The output of the oscillator is divided and synthesized to the proper sub-audible frequency according to the programmed setting on the external 5 position DIP switch. This lower frequency is then fed to the resistor network in digital form. The resistor network combines all the outputs from the IC-107, and produces a triangle wave on its output. This output is shaped into a low distortion sinewave by diodes D5 and D6. The sine wave is then filtered and amplified by the op-amp producing a high level sine wave output.

### DECODE SECTION

The decoder input is processed through a 4 pole low pass filter to eliminate all frequencies passing into the decoder except the

desired sub-audible tone. This filtered output is then amplified and fed into the bandpass filter. The low level output of the filter is then re-amplified and converted to a DC level which is compared to a reference in the last stage of the op-amp. If the DC input level exceeded the level of the reference voltage, then the output of this stage (pin 7) will switch high and activate the switching transistors. Thus, the decoder action can be verified by probing pin 7 of the LM 324.

### AUDIO FILTER SECTION

This is a 3 pole High Pass Filter which attenuates all frequencies below 300Hz. The frequency selective components determine the cutoff frequency, and the rate of attenuation. The audio mute line controls the audio passing through the filter. If no decoded tone is received, then this line is at ground potential. When the proper tone is received, then OUT-2 ungrounds the line and releases control of the audio filter.

## TROUBLE-SHOOTING HINTS

1. Verify all waveforms shown on the block diagram above.
2. Check all bias voltages shown on the schematic diagram.
3. To test OUT-1 or OUT-2, connect a 10K resistor from +V to

OUT-1 or OUT-2 respectively.

4. When testing OUT-1 or OUT-2 be sure the proper jumpers are removed.